

## SP200, SP300, AllPro Mustang 2400, Mustang 3100

3A0994F

EN

*For portable spray application of architectural paints and coatings.  
For professional use only.*



### IMPORTANT SAFETY INSTRUCTIONS.

Read all warnings and instructions in this manual and related manuals. Be familiar with the controls and the proper usage of the equipment. Save these instructions.

## **WARNING**

### FIRE AND EXPLOSION HAZARD

#### SP200/Mustang 2400 Model

- Use only non-flammable or water-based materials, or non-flammable paint thinners. Do not use materials having flash points lower than 100°F (38°C). This includes, but is not limited to, acetone, xylene, toluene, and naphtha. For more information about your material, request Safety Data Sheet (SDS) from the supplier.
- Spraying flammable or combustible materials in a factory or fixed location must comply with NFPA 33 and OSHA 1910.94(c) requirements in the USA and with all similar local regulations in other countries.

See page 2 for model information, including maximum working pressure and approvals.

**SP200 Model 24F557  
Mustang 2400 Model 24F559**

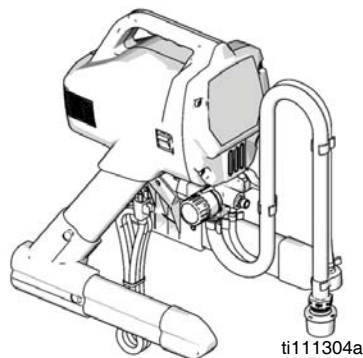

**SP300 Model 24F558  
Mustang 3100 Model 24F560**

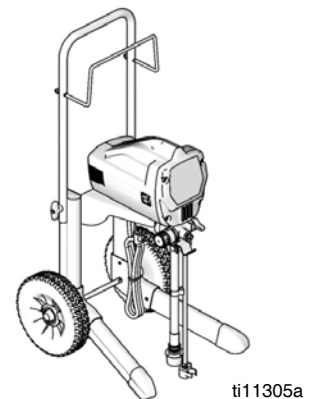

## Models

This equipment is not intended for use with flammable or combustible materials used in places such as cabinet shops or other “factory”, or fixed locations. If you intend to use this equipment in this type of application, you must comply with NFPA 33 and OSHA requirements for the use of flammable and combustible materials.

| <b>Model Name</b>     | <b>Series</b> | <b>Dispense Rate gpm<br/>(lpm)</b> | <b>Hose Length and<br/>Diameter</b> | <b>Gun Model</b> | <b>Maximum Working Pressure</b> |
|-----------------------|---------------|------------------------------------|-------------------------------------|------------------|---------------------------------|
| SP200<br>Mustang 2400 | A             | 0.24 gpm<br>(0.91 lpm)             | 1/4 in. x 25 ft<br>(6.4 mm x 7.5 m) | Mustang 2        | 2800 psi (19 MPa, 193 bar)      |
| SP300<br>Mustang 3100 | A             | 0.34 gpm<br>(1.29 lpm)             | 1/4 in. x 50 ft<br>(6.4 mm x 15m)   | 500 Series       | 3000 psi (21 MPa, 207 bar)      |

# Warnings

The following warnings are for the setup, use, grounding, maintenance, and repair of this equipment. The exclamation point symbol alerts you to a general warning and the hazard symbols refer to procedure-specific risks. When these symbols appear in the body of this manual, refer back to these Warnings. Product-specific hazard symbols and warnings not covered in this section may appear throughout the body of this manual where applicable.

## WARNING



### GROUNDING

This product must be grounded. In the event of an electrical short circuit, grounding reduces the risk of electric shock by providing an escape wire for the electric current. This product is equipped with a cord having a grounding wire with an appropriate grounding plug. The plug must be plugged into an outlet that is properly installed and grounded in accordance with all local codes and ordinances.

- Improper installation of the grounding plug is able to result in a risk of electric shock.
- When repair or replacement of the cord or plug is required, do not connect the grounding wire to either flat blade terminal.
- The wire with insulation having an outer surface that is green with or without yellow stripes is the grounding wire.
- Check with a qualified electrician or serviceman when the grounding instructions are not completely understood, or when in doubt as to whether the product is properly grounded.
- Do not modify the plug provided; if it does not fit the outlet, have the proper outlet installed by a qualified electrician.
- This product is for use on a nominal 120V circuit and has a grounding plug similar to the plugs illustrated in the figure below.

120V US

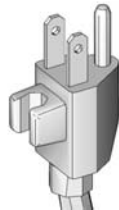



- Only connect the product to an outlet having the same configuration as the plug.
- Do not use an adapter with this product.



#### Extension Cords:

- Use only a 3-wire extension cord that has a grounding plug and a grounding receptacle that accepts the plug on the product.
- Make sure your extension cord is not damaged. If an extension cord is necessary, use 12 AWG (2.5 mm<sup>2</sup>) minimum to carry the current that the product draws.
- An undersized cord results in a drop in line voltage and loss of power and overheating.

# **WARNING**





|   |   |
|---|---|
|    | <p><b>FIRE AND EXPLOSION HAZARD</b></p> <p>Flammable fumes, such as solvent and paint fumes, in work area can ignite or explode. To help prevent fire and explosion:</p> <ul style="list-style-type: none"> <li>• Do not spray or clean with materials having flash points lower than 100°F (38°C). Use only non-flammable or water-based materials, or non-flammable paint thinners. For complete information about your material, request the Safety Data Sheet (SDS) from the material distributor or retailer.</li> <li>• Do not spray combustible materials near an open flame or sources of ignition such as cigarettes, motors, and electrical equipment.</li> <li>• Paint or solvent flowing through the equipment is able to result in static electricity. Static electricity creates a risk of fire or explosion in the presence of paint or solvent fumes. All parts of the spray system, including the pump, hose assembly, spray gun, and objects in and around the spray area shall be properly grounded to protect against static discharge and sparks. Use Graco conductive or grounded high-pressure airless paint sprayer hoses.</li> <li>• Verify that all containers and collection systems are grounded to prevent static discharge. Do not use pail liners unless they are anti-static or conductive.</li> <li>• Connect to a grounded outlet and use grounded extensions cords. Do not use a 3-to-2 adapter.</li> <li>• Do not use a paint or a solvent containing halogenated hydrocarbons.</li> <li>• Do not spray combustible liquids in a confined area.</li> <li>• Keep spray area well-ventilated. Keep a good supply of fresh air moving through the area.</li> <li>• Sprayer generates sparks. Keep pump assembly in a well ventilated area a least 20 feet (6.1 m) from the spray area when spraying, flushing, cleaning, or servicing. Do not spray pump assembly.</li> <li>• Do not smoke in the spray area or spray where sparks or flame is present.</li> <li>• Do not operate light switches, engines, or similar spark producing products in the spray area.</li> <li>• Keep area clean and free of paint or solvent containers, rags, and other flammable materials.</li> <li>• Know the contents of the paints and solvents being sprayed. Read all Safety Data Sheet (SDS) and container labels provided with the paints and solvents. Follow the paint and solvents manufacturer's safety instructions.</li> <li>• Fire extinguisher equipment shall be present and working.</li> </ul> |
|  | <p><b>ELECTRIC SHOCK HAZARD</b></p> <p>This equipment must be grounded. Improper grounding, setup, or usage of the system can cause electric shock.</p> <ul style="list-style-type: none"> <li>• Turn off and disconnect power cord before servicing equipment.</li> <li>• Connect only to grounded electrical outlets.</li> <li>• Use only 3-wire extension cords.</li> <li>• Ensure ground prongs are intact on power and extension cords.</li> <li>• Do not expose to rain. Store indoors.</li> </ul>  |

# ! WARNING

|   |  |
|---|--|
|    | <p><b>SKIN INJECTION HAZARD</b></p> <p>High-pressure spray is able to inject toxins into the body and cause serious bodily injury. In the event that injection occurs, <b>get immediate surgical treatment.</b></p> <ul style="list-style-type: none"> <li>• Do not aim the gun at, or spray any person or animal.</li> <li>• Keep hands and other body parts away from the discharge. For example, do not try to stop leaks with any part of the body.</li> <li>• Always use the nozzle tip guard. Do not spray without nozzle tip guard in place.</li> <li>• Use Graco nozzle tips.</li> <li>• Use caution when cleaning and changing nozzle tips. In the case where the nozzle tip clogs while spraying, follow the <b>Pressure Relief Procedure</b> for turning off the unit and relieving the pressure before removing the nozzle tip to clean.</li> <li>• Equipment maintains pressure after power is shut off. Do not leave the equipment energized or under pressure while unattended. Follow the <b>Pressure Relief Procedure</b> when the equipment is unattended or not in use, and before servicing, cleaning, or removing parts.</li> <li>• Check hoses and parts for signs of damage. Replace any damaged hoses or parts.</li> <li>• This system is capable of producing 3000 psi. Use Graco replacement parts or accessories that are rated a minimum of 3000 psi.</li> <li>• Always engage the trigger lock when not spraying. Verify the trigger lock is functioning properly.</li> <li>• Verify that all connections are secure before operating the unit.</li> <li>• Know how to stop the unit and bleed pressure quickly. Be thoroughly familiar with the controls.</li> </ul> |
|  | <p><b>EQUIPMENT MISUSE HAZARD</b></p> <p>Misuse can cause death or serious injury.</p> <ul style="list-style-type: none"> <li>• Always wear appropriate gloves, eye protection, and a respirator or mask when painting.</li> <li>• Do not operate or spray near children. Keep children away from equipment at all times.</li> <li>• Do not overreach or stand on an unstable support. Keep effective footing and balance at all times.</li> <li>• Stay alert and watch what you are doing.</li> <li>• Do not operate the unit when fatigued or under the influence of drugs or alcohol.</li> <li>• Do not kink or over-bend the hose.</li> <li>• Do not expose the hose to temperatures or to pressures in excess of those specified by Graco.</li> <li>• Do not use the hose as a strength member to pull or lift the equipment.</li> <li>• Do not spray with a hose shorter than 25 feet.</li> <li>• Do not alter or modify equipment. Alterations or modifications may void agency approvals and create safety hazards.</li> <li>• Make sure all equipment is rated and approved for the environment in which you are using it.</li> </ul>   |
|  | <p><b>PRESSURIZED ALUMINUM PARTS HAZARD</b></p> <p>Use of fluids that are incompatible with aluminum in pressurized equipment can cause serious chemical reaction and equipment rupture. Failure to follow this warning can result in death, serious injury, or property damage.</p> <ul style="list-style-type: none"> <li>• Do not use 1,1,1-trichloroethane, methylene chloride, other halogenated hydrocarbon solvents or fluids containing such solvents.</li> <li>• Do not use chlorine bleach.</li> <li>• Many other fluids may contain chemicals that can react with aluminum. Contact your material supplier for compatibility.</li> </ul>  |







# WARNING

|  |   |
|--|---|
| <br> | <p><b>MOVING PARTS HAZARD</b></p> <p>Moving parts can pinch or amputate fingers and other body parts.</p> <ul style="list-style-type: none"> <li>• Keep clear of moving parts.</li> <li>• Do not operate equipment with protective guards or covers removed.</li> <li>• Pressurized equipment can start without warning. Before checking, moving, or servicing equipment, follow the <b>Pressure Relief Procedure</b> in this manual. Disconnect power or air supply.</li> </ul>            |
|   | <p><b>TOXIC FLUID OR FUMES HAZARD</b></p> <p>Toxic fluids or fumes can cause serious injury or death if splashed in the eyes or on skin, inhaled, or swallowed.</p> <ul style="list-style-type: none"> <li>• Read Safety Data Sheet (SDS) to know the specific hazards of the fluids you are using.</li> <li>• Store hazardous fluid in approved containers, and dispose of it according to applicable guidelines.</li> </ul>   |
|   | <p><b>PERSONAL PROTECTIVE EQUIPMENT</b></p> <p>Wear appropriate protective equipment when in the work area to help prevent serious injury, including eye injury, hearing loss, inhalation of toxic fumes, and burns. Protective equipment includes but is not limited to:</p> <ul style="list-style-type: none"> <li>• Protective eyewear, and hearing protection.</li> <li>• Respirators, protective clothing, and gloves as recommended by the fluid and solvent manufacturer.</li> </ul> |
|  | <p><b>CALIFORNIA PROPOSITION 65</b></p> <p>This product contains a chemical known to the State of California to cause cancer, birth defects or other reproductive harm. Wash hands after handling.</p>  |

# Installation

## Grounding and Electric Requirements

|   |   |   |   |  |
|---|---|---|---|--|
|    |  |  |  |  |
| <p><b>Sprayer</b> must be grounded. Grounding reduces the risk of static and electric shock by providing an escape wire for electrical current due to static build up or in the event of a short circuit.</p> |   |   |   |  |

- The 120 Vac sprayers require a 120 Vac, 60 Hz, 15A circuit with a grounding receptacle.

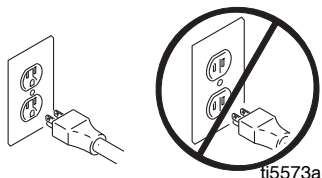

- Never use an outlet that is not grounded or an adapter.

- Do not use the sprayer if the electrical cord has a damaged ground prong.



- Only use an extension cord with an undamaged 3-prong plug.

Recommended extension cords for use with this sprayer:

- 50 ft (15.0 m) 14 AWG (2.1 mm<sup>2</sup>)
- 100 ft (30.0 m) 12 AWG (3.3 mm<sup>2</sup>)

**Spray gun:** ground through connection to a properly grounded fluid hose and pump.

**NOTE:** Smaller gauge or longer extension cords may reduce sprayer performance.

**Fluid supply container:** follow local code.

**Solvent pails used when flushing:** follow local code. Use only conductive metal pails, placed on a grounded surface such as concrete. Do not place the pail on a nonconductive surface, such as paper or cardboard, which interrupts grounding continuity.



**Grounding the metal pail:** connect a ground wire to the pail by clamping one end to pail and other end to ground such as a water pipe.

**Maintaining grounding continuity when flushing or relieving pressure:** hold metal part of the spray gun firmly to the side of a grounded metal pail, then trigger the gun.



## Thermal Overload

Motor has a thermal overload switch to shut itself down if overheated. If unit overheats, allow approximately 45 minutes for unit to cool. Once cool, switch will close and unit will restart.

|   |   |  |  |  |
|---|---|--|--|--|
|    |  |  |  |  |
| <p>To reduce risk of injury from motor starting unexpectedly when it cools, always turn power switch OFF if motor shuts down.</p> |   |  |  |  |

# Component Identification

|    |  |   |
|----|--|---|
| A  | Airless spray gun  | Dispenses fluid.  |
| B  | Power switch   | Turns sprayer ON and OFF.   |
| C  | Pressure control knob  | Increases (clockwise) and decreases (counter-clockwise) fluid pressure in pump, hose, and spray gun.  |
| D  | Pump fluid outlet fitting  | Threaded connection for paint hose.   |
| E  | InstaClean™ fluid filter<br><b>(SP300, Mustang 3100)</b>                                     | <ul style="list-style-type: none"> <li>Filters fluid coming out of pump to reduce tip plugging and improve finish.</li> <li>Self cleans only during pressure relief.</li> </ul>   |
| F  | ProX Power-Piston™ Pump (behind Easy Access door, not shown)<br><b>(SP300, Mustang 3100)</b> | Pumps and pressurizes fluid and delivers it to paint hose.  |
| F1 | Easy Access™ door<br><b>(SP300, Mustang 3100)</b>  | Easy Access door permits quick access to outlet valve. To remove door, insert flat blade of screwdriver into slot on the bottom of the door.  |
| G  | Suction tube   | Draws fluid from paint pail into pump.  |
| H  | Prime tube (with diffuser)   | Drains fluid in system during priming and pressure relief.  |
| J  | Prime/Spray valve  | <ul style="list-style-type: none"> <li>In PRIME position (pointing down) directs fluid to prime tube.</li> <li>In SPRAY position (pointing forward) directs pressurized fluid to paint hose.</li> <li>Automatically relieves system pressure in overpressure situations.</li> </ul> |
| L  | Inlet screen   | Prevents debris from entering pump.   |
| M  | Paint hose   | Transports high-pressure fluid from pump to spray gun.  |
| Q  | Tip guard  | Reduces risk of fluid injection injury.   |
| R  | Reversible spray tip   | <ul style="list-style-type: none"> <li>Atomizes fluid being sprayed, forms spray pattern and controls fluid flow according to hole size.</li> <li>Reverse unclogs plugged tips without disassembly.</li> </ul>  |
| S  | Gun trigger safety lever (page 10)   | Prevents accidental triggering of spray gun.  |
| T  | Gun fluid inlet fitting  | Threaded connection for paint hose.   |
| U  | Power Flush attachment   | Connects garden hose to suction tube for power flushing water-base fluids.  |
| V  | Gun fluid filter   | Filters fluid entering spray gun to reduce tip clogs.   |
| W  | Hose Wrap Rack   | Stows paint hose. (SP300, Mustang 3100)   |
| X  | Pail Hanger<br><b>(SP300, Mustang 3100)</b>  | For transporting pail by its handle.  |



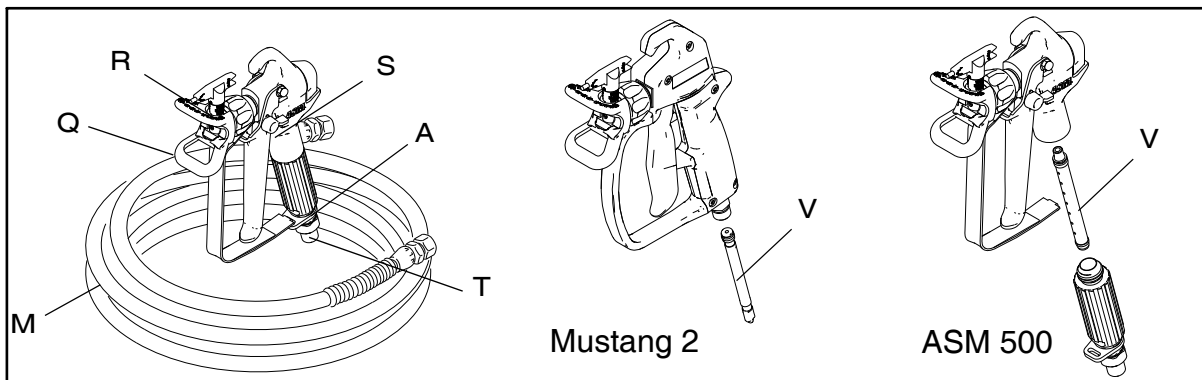
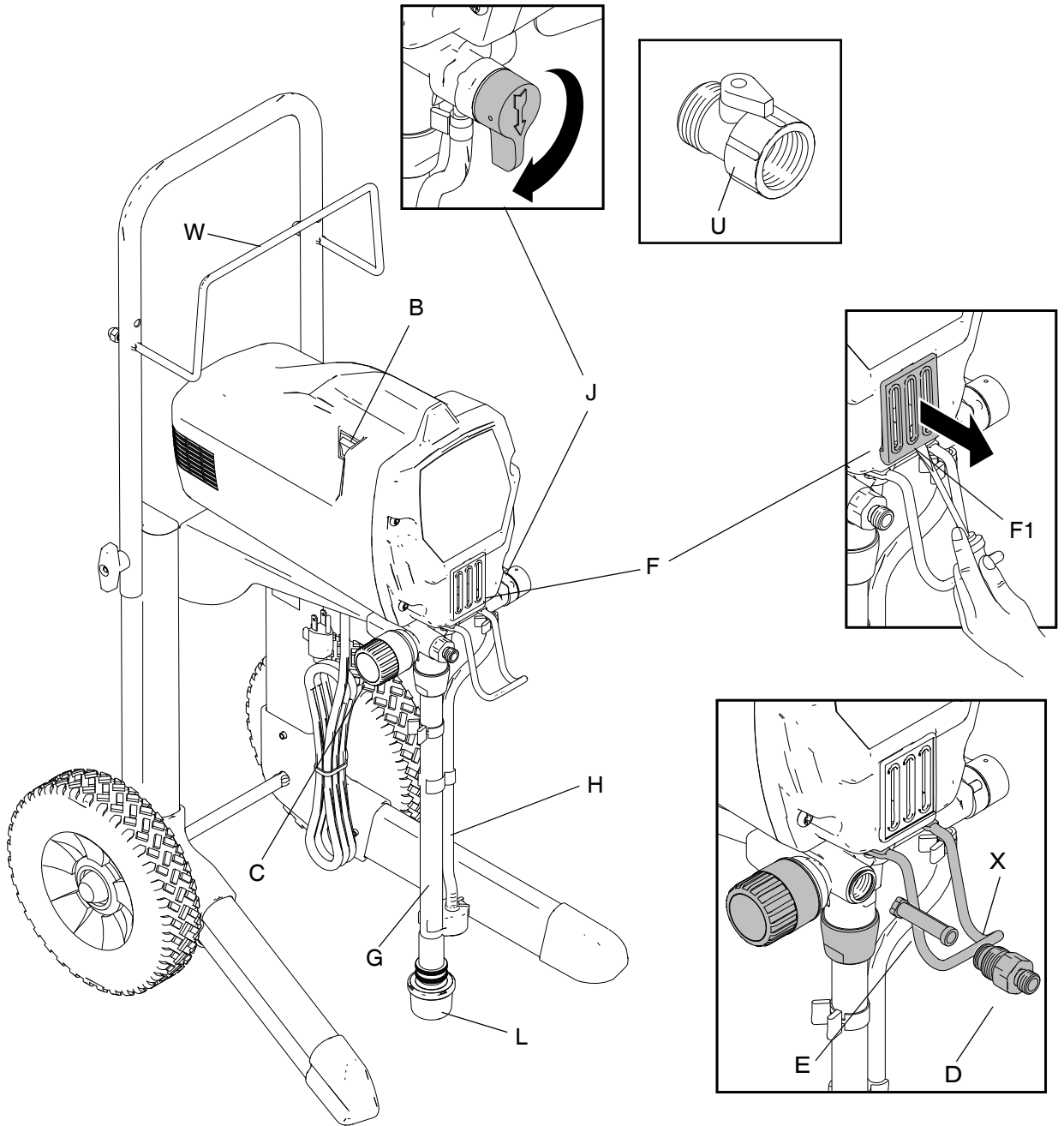

Mustang 2

ASM 500

ti15983a

# Operation



## Trigger Lock

Always engage the trigger lock when you stop spraying to prevent the gun from being triggered accidentally by hand or if dropped or bumped.

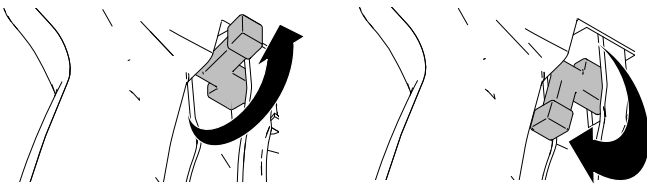

ti15981a

**Trigger Locked Mustang 2**      **Trigger Unlocked Mustang 2**

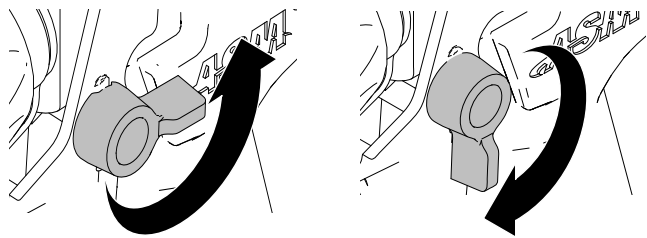

ti115978a

**Trigger Locked ASM 500**      **Trigger Unlocked ASM 500**

## Pressure Relief Procedure

Follow this **Pressure Relief Procedure** whenever you stop spraying and before cleaning, checking, servicing, or transporting equipment.

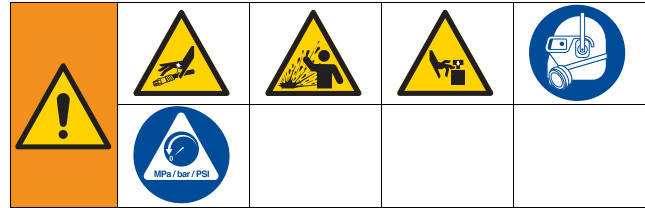

1. Turn power switch OFF and unplug power cord.

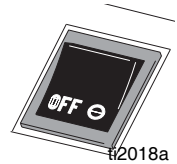

ti2018a

2. Turn Prime/Spray valve to PRIME to relieve pressure.

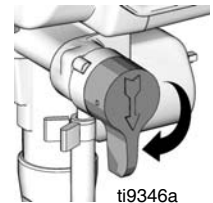

ti9346a

3. Hold gun firmly to side of pail. Trigger the gun to relieve pressure.

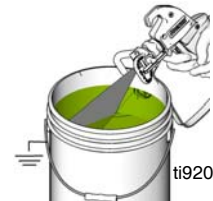

ti9207a

4. Engage trigger lock.

**NOTE:** Leave Prime/Spray valve in the PRIME position until you are ready to spray again.

If you suspect the spray tip or hose is clogged or that pressure has not been fully relieved after following the steps above, **VERY SLOWLY** loosen tip guard retaining nut or hose end coupling to relieve pressure gradually, then loosen completely. Clear hose or tip obstruction. Read Unclogging Spray Tip instructions in the Sprayer or Gun Operation manual.

## Pressure Control Knob Settings

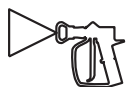

High Pressure Spray



Low Pressure Spray



Prime / Clean



Rolling

ti5597a

To select function, align symbol on pressure control knob with setting indicator on sprayer.

# Setup

1. Unscrew tip and guard assembly from gun.



2. Uncoil hose and connect one end to gun. Use two wrenches to tighten securely

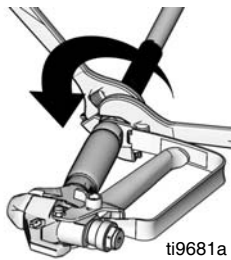

3. Connect other end of hose to sprayer.

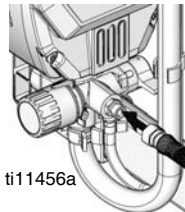

SP200 &  
Mustang 2400

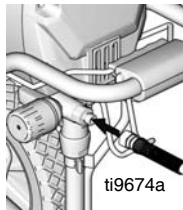

SP300 &  
Mustang 3100

**NOTE:** If hose is already connected, make sure connections are tight.

4. Turn OFF power switch.

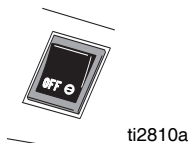

5. Turn Pressure Control Knob all the way left (counter-clockwise) to minimum pressure.



## Prime and Flush Storage Fluid

**NOTE:** To spray lacquers with the SP300 and Mustang 3100, you must purchase lacquer conversion kit 256212, and follow priming procedure for oil-based materials. The SP200 and Mustang 2400 units are not intended for lacquers.

Before you use your sprayer for the first time or begin a new spraying project, you need to prime the sprayer and flush the storage fluid out of the sprayer.

### Oil- or Water-based Materials

- When spraying **water-based** materials, flush the system thoroughly with water.
- When spraying **oil-based** materials, flush the system thoroughly with mineral spirits or compatible, oil-based flushing solvent.
- To spray **water-based** materials **after spraying oil-based** materials, flush the system thoroughly with water first. The water flowing out of prime tube should be clear and solvent-free **before** you begin spraying the water-based material.
- To spray **oil-based** materials **after spraying water-based** materials, flush the system thoroughly with mineral spirits or a compatible oil-based flushing solvent first. The solvent flowing out of the prime tube should not contain any water.
- When flushing with solvents, ground pail and gun. Read Grounding and Electric Requirements, page 7.
- To avoid fluid splashing back on your skin or into your eyes, always aim gun at inside wall of pail.



1. Make sure the power switch is OFF and the sprayer is unplugged.

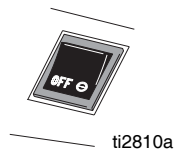

Setup

2. Separate prime tube (smaller) from suction tube (larger).

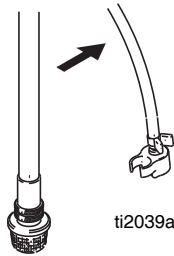

3. Place prime tube in waste pail.



4. Submerge suction tube in water or flushing solvent.



5. Turn Prime/Spray Valve to PRIME.

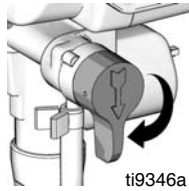

6. Plug sprayer in a grounded outlet.

7. Turn power switch ON.

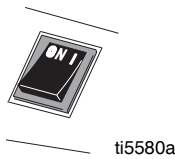

8. Align setting indicator with Prime/Clean setting on Pressure Control knob until pump starts, page 10.

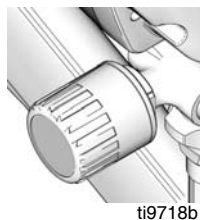

9. When sprayer starts pumping, flushing solvent and air bubbles will be purged from system. Allow fluid to flow out of prime tube, into waste pail, for 30 to 60 seconds.

10. Turn power switch OFF.

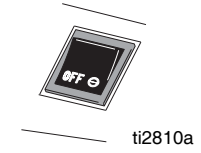

11. Transfer suction tube to paint pail and submerge suction tube in paint.

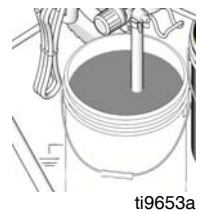

12. Turn power switch ON.

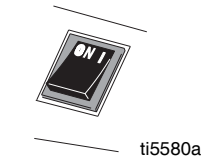

13. When you see paint coming out of prime tube:

- Point gun into waste pail.
- Unlock gun trigger lock.
- Pull and hold gun trigger.
- Turn Prime/Spray valve to SPRAY.

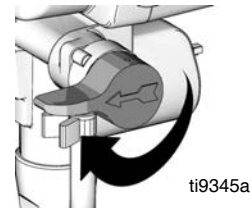
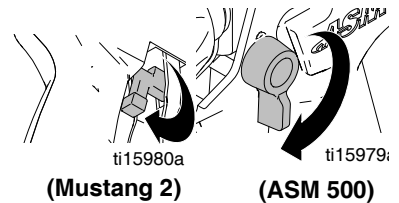

14. Continue to trigger gun into waste pail until you see only paint coming out of gun.

15. Release trigger. Engage trigger lock.

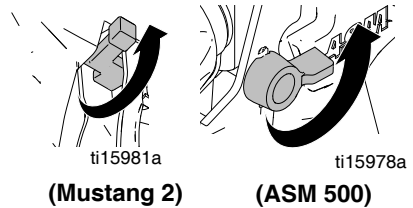

16. Transfer prime tube to paint pail and clip prime tube to suction tube.

**NOTE:** Motor stopping indicates pump and hose are primed with paint. If motor continues to run the sprayer is not properly primed. To reprime repeat step 8.

## Install Tip and Guard on Gun



1. Engage trigger lock.

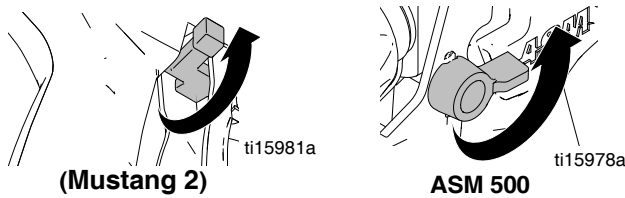

2. Verify tip and guard parts are assembled in order shown.

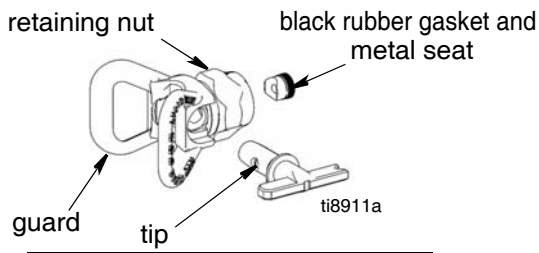

Use tip to align seat in guard

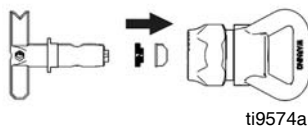

Tip must be pushed all the way into guard

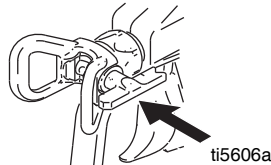

3. Screw tip and guard assembly on gun. Tighten retaining nut.



## Spraying Techniques

### Preventing Excessive Tip Wear

- Spray should be atomized (evenly distributed, no gaps at edges). Start at low pressure setting, increase pressure a little at a time until you see a good spray pattern, without tails.
- Spray at lowest pressure that atomizes paint.
- If maximum sprayer pressure is not enough for a good spray pattern, tip is too worn. See Reversible Spray Tip Selection Chart, page 16.

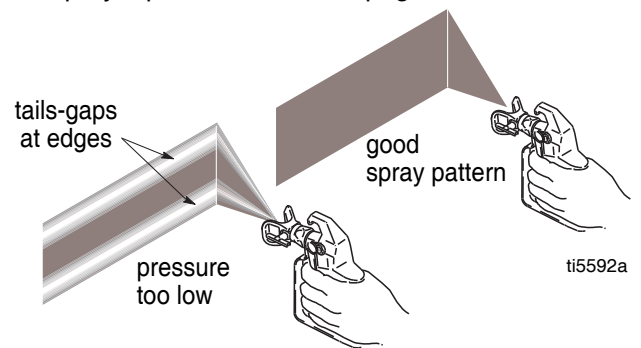

**NOTE:** If tails persist when spraying at the highest pressure, a smaller tip is needed or the material may need to be thinned.

### Adjust Spray Pressure

This sprayer is set up for most airless spraying applications. Details on tip selection, tip wear, coat thickness, etc. are provided on page 15.

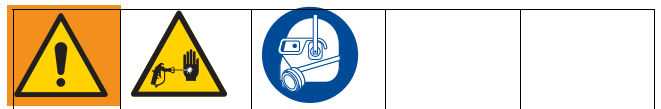

**NOTE:** Motor only runs when gun is triggered. Sprayer is designed to stop pumping when gun trigger is released.

Align setting indicator with function symbol on Pressure Control knob.

- Turning knob to right (clockwise), increases pressure at gun.
- Turning it left (counter-clockwise), decreases pressure.
- General spraying instructions are provided in Getting Started with Basic Spraying Techniques section of this manual, page 17.

## Unclogging Spray Tip



To avoid fluid splash back:

- Never pull gun trigger when arrow-shaped handle is between SPRAY and UNCLOG positions.
- Tip must be pushed all the way into guard.

1. To UNCLOG tip obstruction, engage trigger lock.

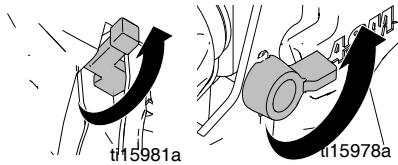

(Mustang 2)

(ASM 500)

2. Point arrow-shaped handle backward to UNCLOG position.

3. Aim gun at piece of scrap or cardboard.

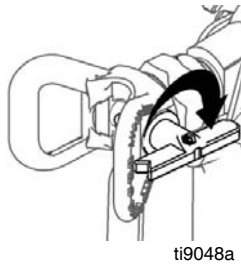

ti9048a

4. Unlock trigger lock. Pull trigger to clear clog.

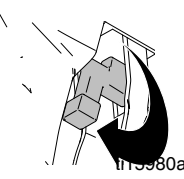

(Mustang 2)

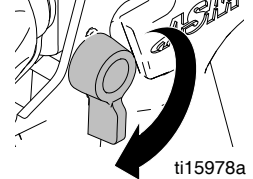

(ASM 500)

5. When obstruction is cleared, engage trigger lock and rotate arrow-shaped handle back to SPRAY position.

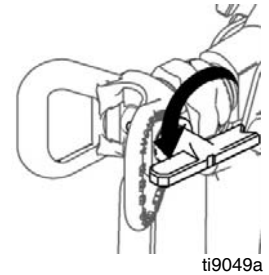

ti9049a

Point the arrow-shaped handle on the spray tip forward to SPRAY and backward to UNCLOG obstructions.

## Tip Selection

### Selecting Tip Hole Size

Tips come in a variety of hole sizes for spraying a range of fluids. Your sprayer includes an 0.015 in (0.38 mm) tip for use in most spraying applications. Use the following table to determine the range of recommended tip hole sizes for each fluid type. If you need a tip other than the one supplied, see the **Reversible Tip Selection Chart** on page 16.

| Tip Hole Size       | Coatings      |                |                |                        |                        |
|---------------------|---------------|----------------|----------------|------------------------|------------------------|
|                     | <i>Stains</i> | <i>Enamels</i> | <i>Primers</i> | <i>Interior Paints</i> | <i>Exterior Paints</i> |
| 0.011 in. (0.28 mm) | ✓             |                |                |                        |                        |
| 0.013 in. (0.33 mm) | ✓             | ✓              | ✓              | ✓                      |                        |
| 0.015 in. (0.38 mm) |               | ✓              | ✓              | ✓                      | ✓                      |
| 0.017 in. (0.43 mm) |               |                | ✓              | ✓                      | ✓                      |

### Choosing the Correct Tip

Consider coating and surface to be sprayed. Make sure you use best tip hole size for that coating and best fan width for that surface.

#### Tip Hole Size

Tip hole size controls flow rate - the amount of paint that comes out of the gun.

##### HINTS:

- Use larger tip hole sizes with thicker coatings and smaller tip hole sizes with thinner coatings.
- Maximum tip hole sizes supported by sprayer:
  - SP200, Mustang 2400: 0.015 in. (0.38 mm)
  - SP300, Mustang 3100: 0.017 in. (0.43 mm)
- Tips wear with use and need periodic replacement.

##### HINTS:

- As you spray, the tip wears and enlarges. Starting with a tip hole size smaller than the maximum will allow you to spray within the rated flow capacity of the sprayer.
- Maximum tip hole sizes supported by the sprayer:
  - SP200, Mustang 2400: 0.015 in. (0.38 mm)
  - SP300, Mustang 3100: 0.017 in. (0.43 mm)

### Fan Width

Fan width is the size of the spray pattern, which determines the area covered with each stroke. Narrower fans deliver a thicker coat, and wider fans deliver a thinner coat.

##### HINTS:

- Select a fan width best suited to the surface being sprayed.
- Wider fans allow provide better coverage on broad, open surfaces.
- Narrower fans provide better control on small, confined surfaces.

### Understanding Tip Number

The last three digits of tip number (i.e.: 221413) contain information about hole size and fan width on surface when gun is held 12 in. (30.5 cm) from surface being sprayed.

First digit when doubled = approximate fan width

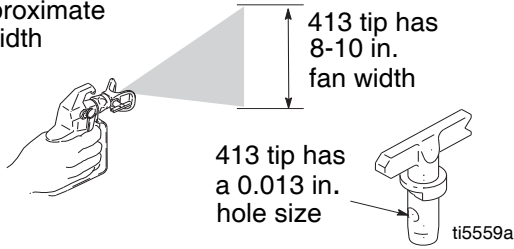

Last two digits = tip hole size in thousands of an inch

### Reversible Tip Selection Chart

| Tip Part No. | Fan Width 12 in. (305 mm) from surface | Hole Size           |
|--------------|--|---------------------|
| 69-311       | 6 - 8 in. (152 - 203 mm)               | 0.011 in. (0.28 mm) |
| 69-411       | 8 - 10 in. (203 - 254 mm)              | 0.011 in. (0.28 mm) |
| 69-313       | 6 - 8 in. (152 - 203 mm)               | 0.013 in. (0.33 mm) |
| 69-413       | 8 - 10 in. (203 - 254 mm)              | 0.013 in. (0.33 mm) |
| 69-415       | 8 - 10 in. (203 - 254 mm)              | 0.015 in. (0.38 mm) |
| 69-515       | 10 - 12 in. (254 - 305 mm)             | 0.015 in. (0.38 mm) |
| 69-417       | 8 - 10 in. (203 - 254 mm)              | 0.017 in. (0.43 mm) |
| 69-517       | 10 - 12 in. (254 - 305 mm)             | 0.017 in. (0.43 mm) |

**Example:** For an 8 to 10 in. (203 to 254 mm) fan width and 0.013 (0.33 mm) hole size, order Part No. 69-413.



# Getting Started With Basic Techniques

Use a piece of scrap cardboard to practice these basic spraying techniques before you begin spraying the surface.

- Hold gun 12 in. (30 cm) from surface and aim straight at surface. Tilting gun to direct spray angle causes an uneven finish.

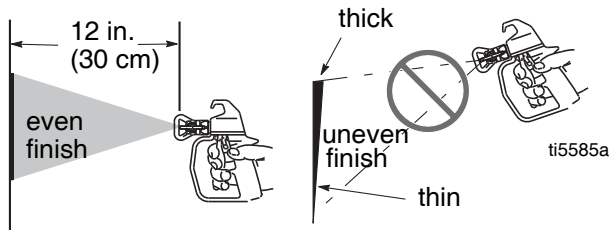

- Flex wrist to keep gun pointed straight. Fanning gun to direct spray at angle causes uneven finish.

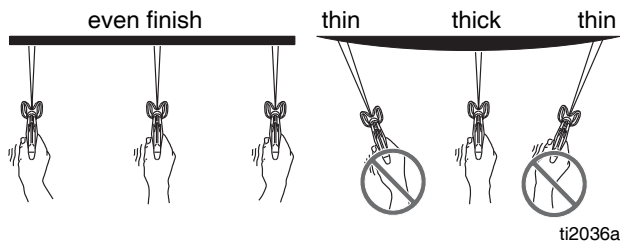

## Triggering Gun

Pull trigger after starting stroke. Release trigger before end of stroke. Gun must be moving when trigger is pulled and released.

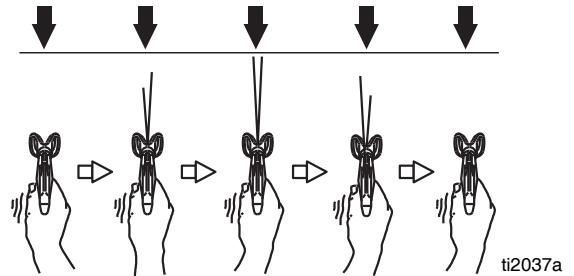

## Aiming Gun

Aim tip of gun at bottom edge of previous stroke, overlapping each stroke by half.

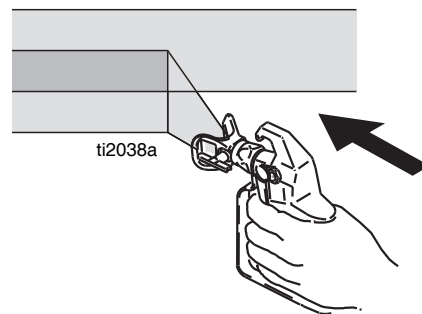

# Shutdown and Cleaning

## Pail Flushing

- For short term shutdown periods (overnight to two days) refer to Short Term Storage, page 23.
- For flushing after spraying oil-based coatings, use compatible oil-based flushing fluid or mineral spirits. Read Priming and Flushing Storage Fluid, page 11.
- For flushing after spraying water-based coatings, use water. Read Priming and Flushing Storage Fluid, page 11 or Power Flush, page 20.



1. **Relieve pressure**, page 10.
2. Remove tip and guard assembly from gun and place in flushing fluid.
3. Lift suction tube and prime tube from paint pail. Let them drain into paint pail for a while.
4. Separate prime tube (smaller) from suction tube (larger).

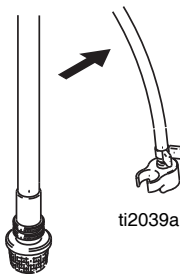

5. Place empty waste and water or solvent pails side by side.

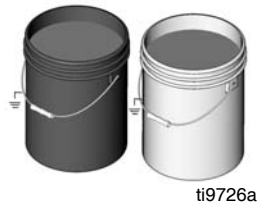

6. Place prime tube in waste pail.

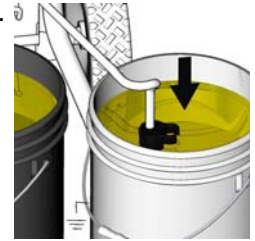

ti9652a

7. Submerge suction tube in water or flushing solvent.



ti9651a

8. Turn pressure control knob to the Prime/Clean setting.



ti9344a

9. Turn power switch ON.

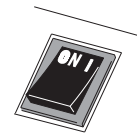

ti5580a

10. Flush until approximately 1/3 of the flushing fluid is emptied from the pail.

11. Turn power switch OFF.

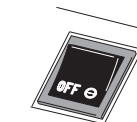

ti2018a

**NOTE:** Step 12 is for returning paint in hose back to paint pail. One 50-ft hose holds approximately 1-quart (1-liter) of paint.

12. To preserve paint in hose:

a. Point gun into paint pail.

b. Unlock gun trigger lock.

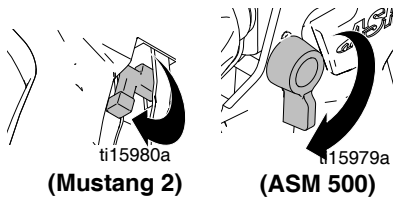

c. Pull and hold gun trigger.

d. Turn Prime/Spray valve to SPRAY.

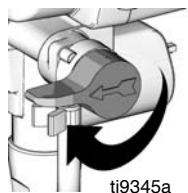

e. Turn power switch ON.

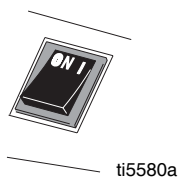

f. Continue to hold gun trigger until you see paint diluted with flushing fluid starting to come out of gun.

13. While continuing to trigger gun, quickly move gun to redirect spray into waste pail. Continue triggering gun into waste pail until flushing fluid dispensed from gun is relatively clear.



14. Stop triggering gun. Engage the trigger lock.

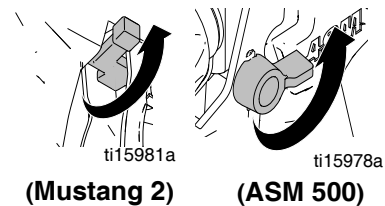

15. Turn prime/spray valve to Prime.

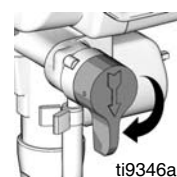

16. Turn power switch OFF.

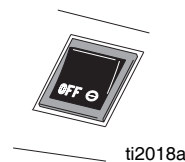

17. Clean InstaClean Fluid Filter and gun, page 22.

18. Fill unit with PumpLife storage fluid. Read Long Term Storage, page 23.

## Power Flush

Power flushing is a faster method of flushing. It can only be used after spraying water-based coatings.



1. **Relieve pressure**, page 10.
2. Remove tip and guard assembly from gun and place in waste pail.
3. Place empty waste and paint pails side by side.



4. Lift suction tube and prime tube from paint pail. Let them drain into paint for a while.
5. Place suction and prime tube in waste pail.
6. Turn Pressure Control knob to the Prime/Clean setting.



7. Screw power flush attachment to garden hose. Close valve.

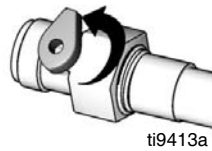

8. Turn on water. Open valve. Rinse paint off suction tube, prime tube and inlet screen.

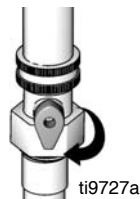

9. Turn lever to close power flush attachment.

10. Unscrew inlet screen from suction tube. Place inlet screen in waste pail.

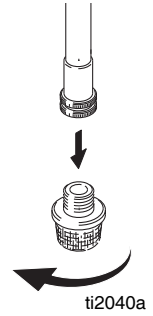

11. Connect garden hose to suction tube with Power Flush attachment. Leave prime tube in waste pail.

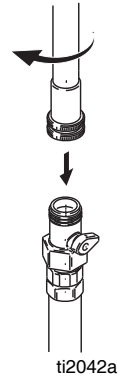

12. Turn power switch ON.

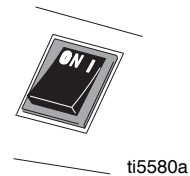

13. Open lever on Power Flush attachment.

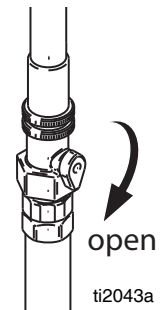

14. Circulate water through sprayer, into waste pail, for 20 seconds.

15. Turn power switch OFF.

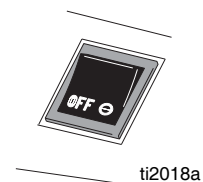

**NOTE:** Step 16 is for returning paint in hose back to paint pail. One 50-ft (15-m) hose holds approximately 1-quart (1-liter) of paint.

16. To preserve paint in hose:

a. Point gun into paint pail.

b. Unlock gun trigger lock.

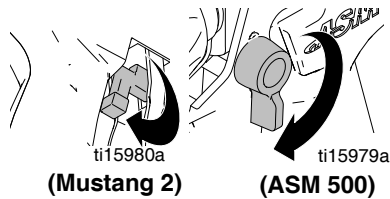

c. Pull and hold gun trigger.

d. Turn Prime/Spray valve to SPRAY.

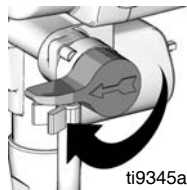

e. Turn power switch ON.

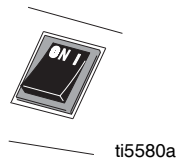

f. Continue to hold gun trigger until you see paint diluted with water starting to come out of gun.

17. While continuing to trigger gun, quickly move gun to redirect spray into waste pail. Continue triggering gun into waste pail until water coming out of gun is relatively clear.



18. Stop triggering gun. Engage trigger lock.

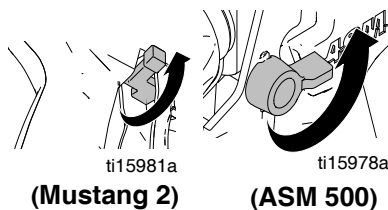

19. Turn prime/spray valve to Prime.

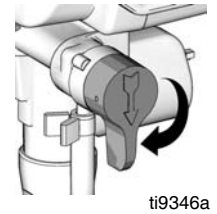

20. Turn power switch OFF.

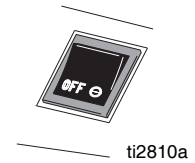

21. Turn off garden hose. Close Power Flush attachment.

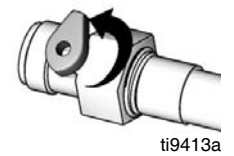

22. Unscrew Power Flush attachment from suction tube.

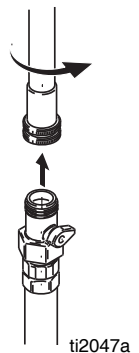

23. Clean InstaClean Fluid Filter and gun, page 22.

24. Fill unit with PumpLife storage fluid. Read Long Term Storage, page 23.

## Cleaning InstaClean™ Fluid Filter (SP300, Mustang 3100 Only)

The InstaClean Fluid Filter prevents particles from entering paint hose. After each use, remove and clean it to insure peak performance.



1. **Relieve pressure**, page 10.

2.

- a. Disconnect airless spray hose (a) from sprayer
- b. Unscrew outlet fitting (b).
- c. Remove InstaClean Fluid Filter (c).

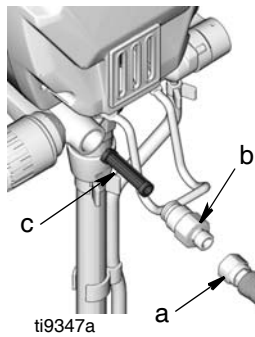

3. Check InstaClean Fluid Filter (c) for debris. If needed, clean filter with water and a soft brush.

- a. Install closed (square) end of InstaClean Fluid Filter (c) in sprayer.
- b. Screw outlet fitting (b) into sprayer.

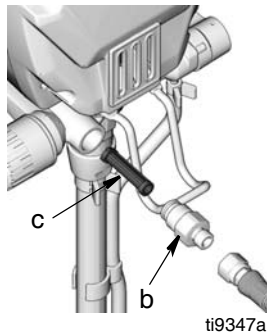

4. Tighten outlet fitting and reconnect hose (a) to sprayer. Use two wrenches to tighten securely.

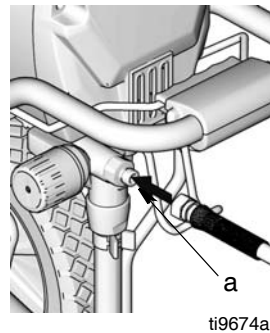

## Cleaning Gun

- Clean gun fluid filter (d) with water or flushing solvent and a brush every time you flush the system. Replace gun filter if damaged.

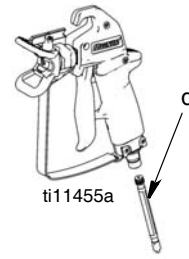

(Mustang 2)

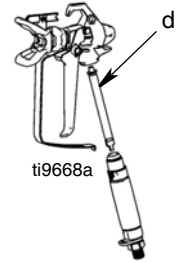

(ASM 500)

- Remove tip and guard and clean with water or flushing solvent. A soft brush can be used to loosen and remove dried on material if needed.
- Wipe paint off outside of gun using a soft cloth moistened with water or flushing solvent.



ti9671a

# Storage

## Short Term Storage

(up to 2 days)



1. **Relieve pressure**, page 10.
2. Leave suction tube and prime tube in paint pail.

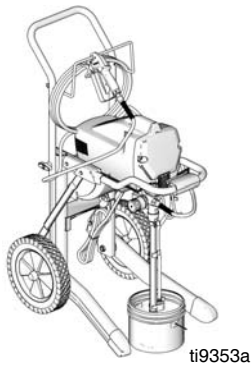

3. Cover paint pail and hoses tightly with plastic wrap.



4.
  - a. Engage trigger lock.

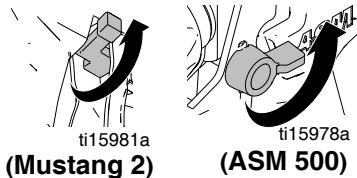

- b. Leave gun attached to hose.

- c. If you have not already cleaned them, remove tip and guard from gun and clean with water or flushing solvent. A soft brush can be used to loosen and remove dried on material if needed.



- d. Wipe paint off outside of gun using a soft cloth moistened with water or flushing solvent.

## Long Term Storage

(more than 2 days)



- Always circulate PumpLife storage fluid through system after cleaning. Water left in sprayer will corrode and damage pump.
- Follow Shutdown and Cleaning, page 18, or Power Flush Cleaning, page 20.

1. Place suction tube in PumpLife storage fluid bottle and prime tube in waste pail.

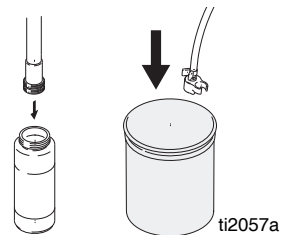

2. Turn Prime/Spray valve to **PRIME**.

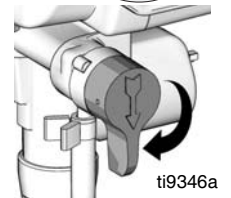

3. Turn power switch **ON**.

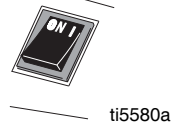

4. Turn pressure control knob clockwise until the pump turns on.

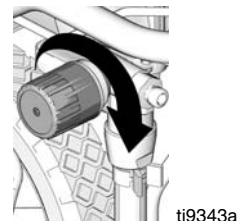

5. When storage fluid comes out of prime tube (5-10 seconds) turn power switch **OFF**.

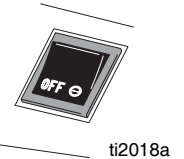

6. Turn Prime/Spray valve to **SPRAY** to keep storage fluid in sprayer during storage.

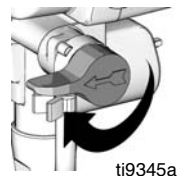

# Stowing Sprayer

**NOTICE**

To prevent damage to the sprayer:

- Make sure all water is drained out of sprayer and hoses before storing.
- Do not allow water to freeze in sprayer or hose.
- Do not store sprayer under pressure.

1. Screw inlet screen onto suction tube.

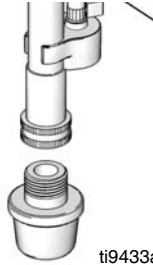

2. Coil hose. Leave it connected to sprayer. Wrap hose around hose wrap bracket.

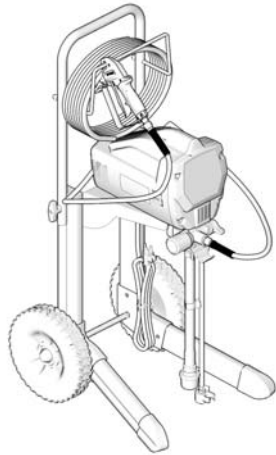

3. Secure a plastic bag around suction tube to catch any drips.
4. Store sprayer indoors.

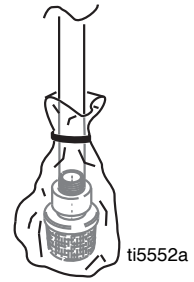



# Maintenance and Service

## NOTICE

**Protect the internal drive parts of this sprayer from water.** Openings in shroud allow cooling of mechanical parts and electronics inside. If water gets into these openings, the sprayer could malfunction or be permanently damaged.

## Caring for Sprayer

Keep sprayer and all accessories clean and in good working order.



ti3388a

To avoid overheating motor, keep vent holes in shroud clear for air flow. Do not cover sprayer while spraying.

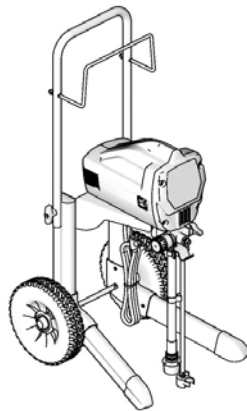

ti11305a

## Paint Hoses

Check hose for damage every time you spray. Do not attempt to repair hose if hose jacket or fittings are damaged. Do not use hoses shorter than 25 ft (7.6 m). Wrench tighten, using two wrenches.

## Tips

- Always clean tips with compatible solvent and brush after spraying.
- Tips may require replacement after 15 gallons (57 liters) or they may last through 60 gallons (227 liters) depending on abrasiveness of paint.
- Do not spray with worn tip.

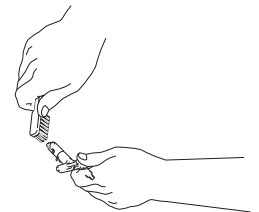

ti2055a

## Pump Packings

When pump packings wear, paint will begin to leak down outside of pump.

- Replace pump packings at first sign of leaking or additional damage could occur.
- Purchase a pump repair kit and install according to instructions provided with kit.
- Consult an Graco/Airlessco authorized service center.

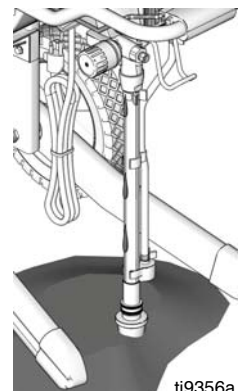

ti9356a

# Troubleshooting



Check everything in this Troubleshooting Table before you bring the sprayer to a Graco/Airlessco authorized service center.

| Problem  | Cause   | Solution  |
|--|---|---|
| Power switch is on and sprayer is plugged in, but motor does not run, and pump does not cycle. | Pressure is set at zero pressure.                 | Turn pressure control knob clockwise to increase pressure setting.  |
|  | Motor or control is damaged.                      | Take sprayer to Graco/Airlessco authorized service center.  |
|  | Electric outlet is not providing power.           | <ul style="list-style-type: none"> <li>• Try a different outlet or plug in something that you know is working to test outlet.</li> <li>• Reset building circuit breaker or replace fuse.</li> </ul>   |
|  | Extension cord is damaged.                        | Replace extension cord. Read Grounding and Electric Requirements, page 7.   |
|  | Sprayer electric cord is damaged.                 | Check for broken insulation or wires. Replace electric cord if damaged.   |
|  | Paint and/or water is frozen or hardened in pump. | Unplug sprayer from outlet. If frozen do NOT try to start sprayer until it is completely thawed or you may damage the motor, control board and/or drivetrain.<br><br>Make sure power switch is OFF. Place sprayer in a warm area for several hours. Then plug in powercord and turn sprayer ON. Slowly increase pressure setting to see if motor will start.<br><br>If paint is hardened in sprayer, pump packings, valves, drivetrain or pressure switch may need to be replaced. Take sprayer to Graco/Airlessco authorized service center. |

| Problem                                     | Cause  | Solution  |
|---|--|---|
| Pump does not prime.                        | Prime/Spray Valve is in SPRAY position.  | Turn Prime/Spray Valve to PRIME position (pointing down).   |
|   | Inlet screen is clogged or suction tube is not immersed.                               | Clean debris off inlet screen and make sure suction tube is immersed in fluid.  |
|   | Pump was not primed with flushing fluid.   | Remove suction tube from paint. Prime pump with water or solvent-based flushing fluid, page 11.   |
|   | Inlet valve check ball is stuck.   | Remove suction tube and place a pencil into the inlet section to dislodge the ball, allowing pump to prime properly. OR Power Flush sprayer, page 20.   |
|   |  | AutoPrime may need replacement. Turn power switch ON and listen for “tap” in pump. If you do not hear “tap”, AutoPrime is damaged. Take sprayer to Graco/Airlessco authorized service center.   |
|   | Inlet valve check ball or seat is dirty  | Remove inlet fitting. Clean or replace ball and seat.   |
|   | Outlet valve check ball is stuck.  | <p><b>SP300 and Mustang 3100:</b> Insert screw driver in slot and remove Easy-Access™ door. Unscrew outlet valve with a 3/4 in. socket. Remove and clean assembly.</p> <p><b>SP200 and Mustang 2400:</b> Remove outlet fitting and clean outlet check ball.</p> |
|   | Suction tube is leaking.   | Tighten suction tube connection. Inspect for cracks or vacuum leaks.  |
| Pump does not prime with fluid.             | Remove suction tube from paint. Prime pump with water or solvent-based flushing fluid. |   |
| Pump cycles but does not build up pressure. | Pump is not primed.  | Prime pump.   |
|   | Inlet screen is clogged .  | Clean debris off inlet screen and make sure suction tube is immersed in fluid.  |
|   | Suction tube is not immersed in paint.   | Make sure suction tube is immersed in paint.  |
|   | Suction tube is leaking.   | Tighten suction tube connection. Inspect for cracks or vacuum leaks. If cracked or damaged, replace suction tube.   |
|   | Prime/Spray Valve is worn or obstructed with debris.                                   | Take sprayer to Graco/Airlessco authorized service center.  |
|   | Pump check ball is stuck.  | Read <b><i>Pump does not prime</i></b> section in Troubleshooting.  |

| Problem   | Cause   | Solution  |
|---|---|---|
| Pump cycles, but paint only dribbles or spurts when spray gun is triggered. | Pressure is set too low.                              | Slowly turn Pressure Control Knob clockwise to increase pressure setting which will turn motor on to build pressure.  |
|   | Spray tip is clogged.                                 | Unclog spray tip, page 14.  |
|   | InstaClean fluid filter is clogged.                   | Clean or replace InstaClean fluid filter, page 22.  |
|   | Spray gun fluid filter is clogged.                    | Clean or replace gun fluid filter, page 22.   |
|   | Spray tip is too large or worn.                       | Replace tip.  |
| Pressure is set at maximum but cannot achieve a good spray pattern.         | Reversible spray tip is in UNCLOG position.           | Rotate arrow-shaped handle on spray tip so it points forward in SPRAY position, page 14.  |
|   | Spray tip is too large for sprayer.                   | Select smaller spray tip.   |
|   | Spray tip is worn beyond capability of sprayer.       | Replace spray tip.  |
|   | Extension cord is too long or not heavy enough gauge. | Replace extension cord. Grounding and Electrical Requirements, page 7.  |
|   | Spray gun fluid filter is clogged.                    | Clean or replace spray gun fluid filter, page 22.   |
|   | InstaClean fluid filter is clogged.                   | Clean or replace InstaClean fluid filter, page 22.  |
|   | Inlet screen is clogged.                              | Clean debris off inlet screen.  |
|   | Pump valves are worn, or debris is clogging a valve.  | Check for worn pump valves. <ul style="list-style-type: none"> <li>a. Prime sprayer with paint</li> <li>b. Trigger gun momentarily. When trigger is released, pump should cycle momentarily and stop. If pump continues to cycle, pump valves may be worn.</li> <li>c. Remove valves and check for debris.</li> </ul> |
|   | Material is too thick.                                | Thin material.  |
| Hose is too long (if extra section is added).                               | Remove section of hose.                               |   |
| Spray gun stopped spraying.   | Suction tube is leaking.                              | Tighten suction tube connection. Inspect for cracks or vacuum leaks.  |
|   | Spray tip is clogged.                                 | Unclog spray tip, page 14.  |
| When paint is sprayed, it runs down the wall or sags.                       | Coat is going on too thick.                           | Move gun faster.  |
|   |   | Choose a tip with smaller hole size.  |
|   |   | Choose tip with wider fan.  |
|   |   | Make sure gun is far enough from surface.   |

| Problem   | Cause   | Solution   |
|---|---|--|
| When paint is sprayed, coverage is inadequate.  | Coat is going on too thin.  | Move gun slower.   |
|   |   | Choose tip with larger hole size.  |
|   |   | Choose tip with narrower fan.  |
|   |   | Make sure gun is close enough to surface.  |
| Fan pattern varies dramatically while spraying.<br><br>OR<br><br>Sprayer does not turn on promptly when resuming spraying.  | Pressure control switch is worn and causing excessive pressure variation. | Take sprayer to Graco/Airlessco authorized service center.   |
| Cannot trigger spray gun.   | Spray gun trigger lock is locked.   | Rotate trigger safety lever to unlock trigger lock, page 10.   |
| Paint is coming out of pressure control switch.   | Pressure control switch is worn.  | Take sprayer to Graco/Airlessco authorized service center.   |
| Prime/Spray valve actuates automatically relieving pressure through prime tube.   | System is over pressurizing.  | Take sprayer to Graco/Airlessco authorized service center.   |
| Paint leaks down outside of pump.   | Pump packings are worn.   | Replace pump packings.   |
| Motor is hot and runs intermittently. Motor automatically shuts off due to excessive heat. Damage can occur if cause is not corrected.<br><b>Thermal Overload</b> , page 7. | Vent holes in enclosure are plugged or sprayer is covered.                | Keep vent holes clear of obstructions and overspray and keep sprayer open to air.                              |
|   | Extension cord is too long or not a heavy enough gauge.                   | Replace extension cord. Read Grounding and Electrical Requirements, page 7.                                    |
|   | Unregulated electrical generator being used has excessive voltage.        | Use electrical generator with a proper voltage regulator. Sprayer requires 120VAC, 60 Hz, 1500-Watt generator. |

# Technical Data

## SP200, Mustang 2400

|   |   |
|---|---|
| Electrical Power Requirements . . . . .     | <b>120 Vac, 60 Hz, 15A, 1 phase</b>   |
| Working Pressure Range . . . . .            | 0 - 2800 psi (0-19 MPa, 0-193 bar)  |
| Generator required . . . . .                | 1500W minimum   |
| Electric Motor . . . . .                    | 9.0A (open frame, universal)  |
| Operating horsepower. . . . .               | 1/2   |
| Power Cord . . . . .                        | 18 AWG, 3-wire, 6 ft (1.8m)   |
| Fluid inlet fitting . . . . .               | 3/4 in. internal thread (standard garden hose thread)   |
| Fluid outlet fitting . . . . .              | 1/4 NPSM external thread  |
| Inlet screen (on suction tube) . . . . .    | 35 mesh (450 micron)  |
| Maximum Delivery (with tip) . . . . .       | 0.24 gpm (0.91 lpm)   |
| Paint Hose . . . . .                        | 1/4 in. x 25 ft. (6.4 mm x 7.5 m)   |
| Maximum tip hole size. . . . .              | 0.015 in. (0.38 mm)   |
| Weight, sprayer only . . . . .              | 13.3 lb (6.0 kg)  |
| Weight, sprayer, hose and gun . . . . .     | 16.5 lb (7.5 kg)  |
| <br>Dimensions: Upright                     |   |
| Length . . . . .                            | 14.5 in. (36.8 cm)  |
| Width . . . . .                             | 12.4 in. (31.5 cm)  |
| Height . . . . .                            | 17.9 in. (45.5 cm)  |
| <br>Wetted Parts, pump and hose . . . . .   |   |
|   | stainless steel, brass, leather, ultra-high molecular weight polyethylene (UHMWPE), carbide, nylon, aluminum, PVC, polypropylene, fluoroelastomer |
| <br>Wetted Parts, gun . . . . .             |   |
|   | aluminum, brass, carbide, nylon, plated steel, stainless steel, UHMWPE, zinc  |
| <br>Storage Temperature Range ♦❖. . . . .   |   |
|   | -30°F - 160°F (-35°C - 71°C)  |
| <br>Operating Temperature Range ✓ . . . . . |   |
|   | 40°F - 115°F (4°C - 46°C)   |

- ♦ When pump is stored with non-freezing fluid. Pump damage will occur if water or latex paint freezes in pump.
- ❖ Damage to plastic parts may result if impact occurs in low temperature conditions.
- ✓ Changes in paint viscosity at very low or very high temperatures can affect sprayer performance.

## SP300, Mustang 3100

|   |   |
|---|---|
| Electrical Power Requirements . . . . .     | <b>120 Vac, 60 Hz, 15A, 1 phase</b>   |
| Working Pressure Range . . . . .            | 0 - 3000 psi (0-21 MPa, 0-207 bar)  |
| Generator required . . . . .                | 1500W minimum   |
| Electric Motor . . . . .                    | 5.8A (permanent magnet DC)  |
| Operating horsepower . . . . .              | 3/4   |
| Power Cord . . . . .                        | 16 AWG, 3-wire, 6 ft (1.8m)   |
| Fluid inlet fitting . . . . .               | 3/4 in. internal thread (standard garden hose thread)   |
| Fluid outlet fitting . . . . .              | 1/4 NPSM external thread  |
| Inlet screen (on suction tube) . . . . .    | 35 mesh (450 micron)  |
| Maximum Delivery (with tip) . . . . .       | 0.34 gpm (1.29 lpm)   |
| Paint Hose . . . . .                        | 1/4 in. x 50 ft. (6.4 mm x 15 m)  |
| Maximum tip hole size . . . . .             | 0.017 in. (0.43 mm)   |
| Weight, sprayer only . . . . .              | 43 lb (20 kg)   |
| Weight, sprayer, hose and gun . . . . .     | 46 lb (21 kg)   |
| <br>Dimensions: Upright                     |   |
| Length . . . . .                            | 20.79 in. (60.32 cm)  |
| Width . . . . .                             | 15.27 in. (44.45 cm)  |
| Height . . . . .                            | 36.99 in. (92.71 cm)  |
| <br>Dimensions: Folded                      |   |
| Length . . . . .                            | 20.79 in. (59.05 cm)  |
| Width . . . . .                             | 15.27 in. (44.45 cm)  |
| Height . . . . .                            | 29.81 in. (55.88 cm)  |
| <br>Wetted Parts, pump and hose . . . . .   |   |
|   | stainless steel, brass, leather, ultra-high molecular weight polyethylene (UHMWPE), carbide, nylon, aluminum, PVC, polypropylene, fluoroelastomer |
| <br>Wetted Parts, gun . . . . .             |   |
|   | aluminum, brass, carbide, nylon, plated steel, stainless steel, UHMWPE, zinc  |
| <br>Storage Temperature Range ♦❖ . . . . .  |   |
|   | -30°F - 160°F (-35°C - 71°C)  |
| <br>Operating Temperature Range ✓ . . . . . |   |
|   | 40°F - 115°F (4°C - 46°C)   |

- ♦ When pump is stored with non-freezing fluid. Pump damage will occur if water or latex paint freezes in pump.
- ❖ Damage to plastic parts may result if impact occurs in low temperature conditions.
- ✓ Changes in paint viscosity at very low or very high temperatures can affect sprayer performance.

# Airlessco Standard Warranty

Airlessco warrants all equipment referenced in this document which is manufactured by Airlessco and bearing its name to be free from defects in material and workmanship on the date of sale to the original purchaser for use. With the exception of any special, extended, or limited warranty published by Airlessco, Airlessco will, for a period of twelve months from the date of sale, repair or replace any part of the equipment determined by Airlessco to be defective. This warranty applies only when the equipment is installed, operated and maintained in accordance with Airlessco's written recommendations.

This warranty does not cover, and Airlessco shall not be liable for general wear and tear, or any malfunction, damage or wear caused by faulty installation, misapplication, abrasion, corrosion, inadequate or improper maintenance, negligence, accident, tampering, or substitution of non-Airlessco component parts. Nor shall Airlessco be liable for malfunction, damage or wear caused by the incompatibility of Airlessco equipment with structures, accessories, equipment or materials not supplied by Airlessco, or the improper design, manufacture, installation, operation or maintenance of structures, accessories, equipment or materials not supplied by Airlessco.

This warranty is conditioned upon the prepaid return of the equipment claimed to be defective to an authorized Airlessco distributor for verification of the claimed defect. If the claimed defect is verified, Airlessco will repair or replace free of charge any defective parts. The equipment will be returned to the original purchaser transportation prepaid. If inspection of the equipment does not disclose any defect in material or workmanship, repairs will be made at a reasonable charge, which charges may include the costs of parts, labor, and transportation.

**THIS WARRANTY IS EXCLUSIVE, AND IS IN LIEU OF ANY OTHER WARRANTIES, EXPRESS OR IMPLIED, INCLUDING BUT NOT LIMITED TO WARRANTY OF MERCHANTABILITY OR WARRANTY OF FITNESS FOR A PARTICULAR PURPOSE.**

Airlessco's sole obligation and buyer's sole remedy for any breach of warranty shall be as set forth above. The buyer agrees that no other remedy (including, but not limited to, incidental or consequential damages for lost profits, lost sales, injury to person or property, or any other incidental or consequential loss) shall be available. Any action for breach of warranty must be brought within two (2) years of the date of sale.

**AIRLESSCO MAKES NO WARRANTY, AND DISCLAIMS ALL IMPLIED WARRANTIES OF MERCHANTABILITY AND FITNESS FOR A PARTICULAR PURPOSE, IN CONNECTION WITH ACCESSORIES, EQUIPMENT, MATERIALS OR COMPONENTS SOLD BUT NOT MANUFACTURED BY Airlessco.** These items sold, but not manufactured by Airlessco (such as electric motors, switches, hose, etc.), are subject to the warranty, if any, of their manufacturer. Airlessco will provide purchaser with reasonable assistance in making any claim for breach of these warranties.

In no event will Airlessco be liable for indirect, incidental, special or consequential damages resulting from Airlessco supplying equipment hereunder, or the furnishing, performance, or use of any products or other goods sold hereto, whether due to a breach of contract, breach of warranty, the negligence of Airlessco, or otherwise.

## **FOR AIRLESSCO CANADA CUSTOMERS**

The Parties acknowledge that they have required that the present document, as well as all documents, notices and legal proceedings entered into, given or instituted pursuant hereto or relating directly or indirectly hereto, be drawn up in English. Les parties reconnaissent avoir convenu que la rédaction du présente document sera en Anglais, ainsi que tous documents, avis et procédures judiciaires exécutés, donnés ou intentés, à la suite de ou en rapport, directement ou indirectement, avec les procédures concernées.

***TO PLACE AN ORDER OR FOR SERVICE, contact your Airlessco distributor,  
or call 1-800-223-8213 to identify the nearest distributor.***

*All written and visual data contained in this document reflects the latest product information available at the time of publication.  
Airlessco reserves the right to make changes at any time without notice.*

For patent information, see [www.graco.com/patents](http://www.graco.com/patents)

Original instructions. This manual contains English. MM 3A0994

**GRACO INC. AND SUBSIDIARIES • P.O. BOX 1441 • MINNEAPOLIS MN 55440-1441 • USA**

**Copyright 2010, Graco Inc. All Graco manufacturing locations are registered to ISO 9001.**

[www.airlessco.com](http://www.airlessco.com)  
Revision F, July 2015